

V500e

Launch Edition



Designed for
Urban Logistics

100% electric

Made in EU



Evolution

V500e

A new step towards electrified urban logistics

Designed to be adaptive, flexible, and cost effective. The V500e uses a smart vehicle architecture with interchangeable cargo structures. Cargo boxes for last mile deliveries, custom boxes for postal services, flatbeds for municipalities and many more custom solutions are available.



Up to 300 km range



Up to 600 kg payload



charging at 60 km of range per hour

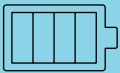

Up to 33 kWh battery



80 km/h top speed



15 kW power



The ONLY original

Made in EU

Our mission is to develop and manufacture user friendly and fully electric commercial vehicles. By combining innovation and creativity, we will convert our planet to electric transportation and allow businesses to become more sustainable.



Made in the European Union



Sustainable solution



Sevic V500e – the ONLY original



Flexible platform for customized solutions



Full digital connectivity



Advanced fleet management

V500e



New Interior

V500e

Clean, modern,
usable

The interior of the Sevic V500e was designed to ensure maximum efficiency without compromising comfort for the driver. All relevant vehicle data is displayed right behind the steering wheel while the infotainment system occupies the large center screen. There is no gear lever and tunnel, making it easier to enter and exit the V500e from both sides.



→ Digital color tachometer

→ Automatic rear-view camera

→ Digital infotainment

→ GPS navigation

→ Smartphone connectivity

→ Heating & air conditioning

→ USB power



Technical Specifications

	BATTERIES		
	13 kWh*	16,5 kWh	33 kWh
HOMOLOGATION EC 168/2012	L7e	L7e	L7e
SIZE IN MM	3705 x 1366 x 1959		
WHEELBASE	2129 mm		
FRONT / REAR WHEEL BASE	1101 mm / 1113 mm		
FRONT / REAR OVERHANG	1080 mm / 485 mm		
MOTOR	Asynchronous 15kW		
CHARGING TIME	5-6 hours (3,3 kW)	6-7 hours (3,3 kW)	12-14 hours (3,3 kW)
	2 hours (9 kW)	2,5 hours (9 kW)	5 hours (9 kW)
NET WEIGHT	757 kg	768 kg	894 kg
LOAD CAPACITY	676 kg	666 kg	576 kg
SPEED	80 km/h		
PERMISSIBLE MAX GROSS WEIGHT	1,510 kg		
TOWING CAPACITY	375 kg		
CLIMBABILITY	12°		

* Available upon special inquiry

** Depending on external factors

	BATTERIES		
	13 kWh*	16,5 kWh	33 kWh
RANGE**	120 km	150 km	300 km
FRONT SUSPENSION	Leaf spring and telescopic damper		
REAR SUSPENSION	Pulled arms with springs and telescopic dampers		
FRONT / REAR BRAKES	Disks		
ELECTRIC POWER STEERING	YES		
HEATING	YES		
A/C	Option		
LED HEADLIGHTS	YES		
CENTRAL LOCK CONTROL	YES		
GPS	YES		
TRACKER WITH FLEET MANAGEMENT	Option		
TIRES	Goodyear efficient performance		
SEATS	Artificial leather		

All figures are preliminary and based on forecasts and are not officially confirmed.

New Cargo Options

V500e

Easy swap system premium quality

The new Sevic V500e has a unique, patented feature. Users can change the cargo options in just 60 seconds. All that is needed is a forklift. The rapid cargo swap enables customers to work with preconfigured cargo boxes in last mile logistics or use the V500e for different purposes. The vehicle is even more flexible with this smart option created by Sevic Systems SE.

- ➔ easily swap the cargo with a forklift in seconds
- ➔ all new, German engineered cargo boxes and flatbeds
- ➔ over 10 different options
- ➔ fully customized solutions to fit the exact needs of customers



1 Easily changing cargo box with a forklift



2 Cargo boxes can be stored and prepared for rapid turnaround times



3 All cargo options work with Cargo Swap



4 From cargo box to pick-up in just 60 seconds

Cargo Options

V500e

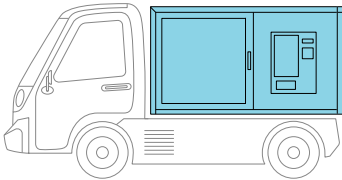

Cargo Box
with Vending Machine

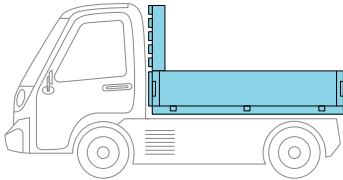

Pick-Up

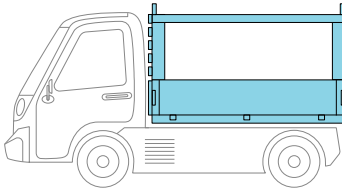

Pick-Up
with Ladder Rack

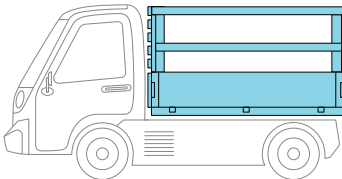

Pick-Up
with Tarpaulin

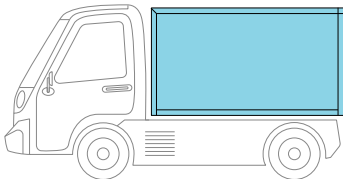

Cargo Box Standard

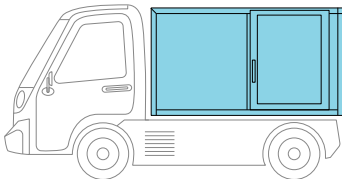

Cargo Box
with Sliding Doors

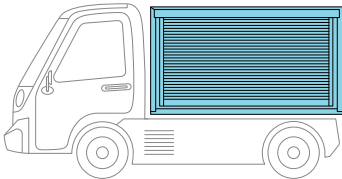

Cargo Box
with Roll-Up Door

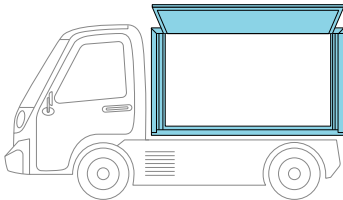

Cargo Box
with Folding Doors

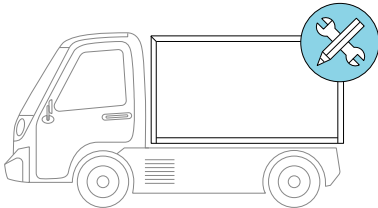

Individual Cargo Box

Dimensions

V500e

width (including mirrors)
1595 mm

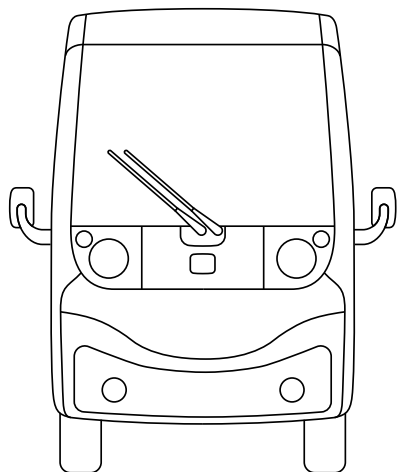
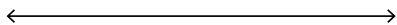

track width front
1102 mm



height (vehicle)
1965 mm

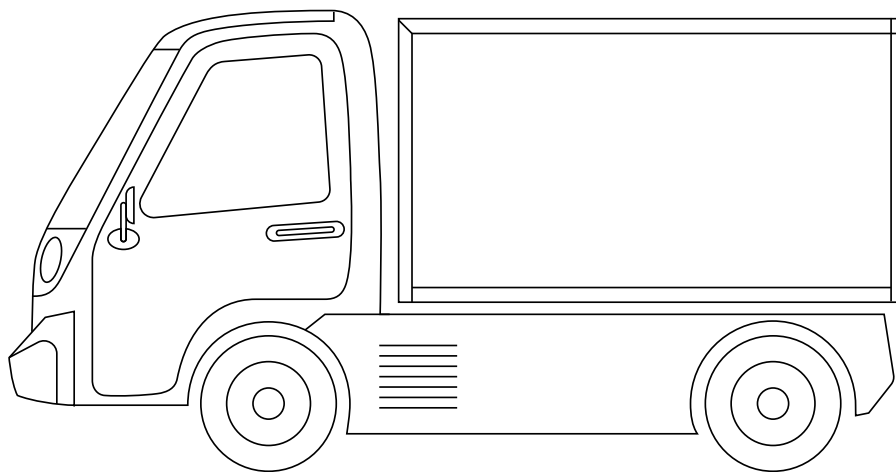

wheelbase
2129 mm



height (cargo
platform)
727 mm

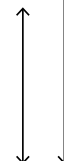

Dimensions

V500e

width (excluding mirrors)
1366 mm

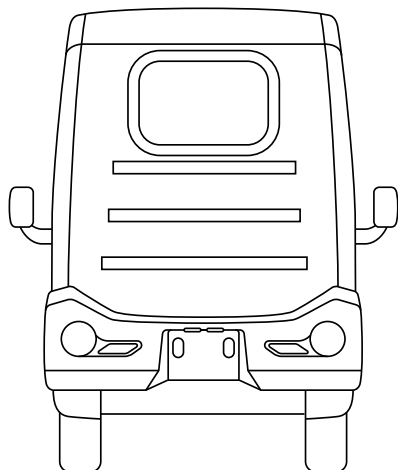

track width rear
1113 mm

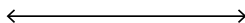

length (overall)
3701 mm

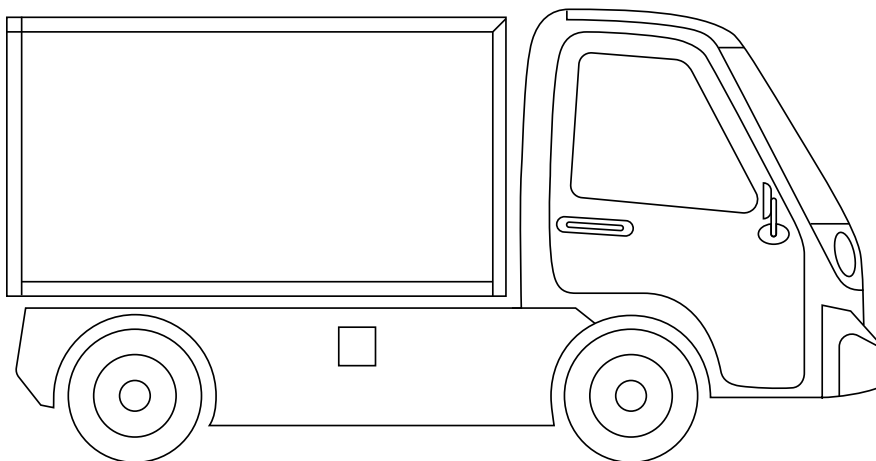

rear overhang
485 mm



front overhang
1087 mm



About Sevic

V500e



Why choose Sevic



Sevic Systems designs, engineers, and manufactures compact fully electric utility vehicles in Europe. Our innovative vehicles are ideally made for last mile solutions and help companies reduce maintenance, labor, and operating costs. We are strategically based in the industrial heart of Germany and have gained important experience from our various success stories in the mobility sector.

We provide advanced urban mobility solutions. Our sophisticated vehicles are suitable for a wide variety of tasks. The modular structure of the V500e allows easy and cost-effective customization. Fulfilling the needs of our customers is our only objective and we always find the ideal configuration for their specific requirements.

Sevic Systems together with Milara International acquired the IP rights and redeveloped the vehicle for matching the needs of demanding professionals. Sevic also cooperated with Magna in France on the technical evolution of the Sevic V500e.

Who we are

Sevic Systems SE was founded with the goal to convert urban logistics and small utility vehicles to electric power. We are a European company and embody the European spirit: quality, innovation, and leadership.

Our headquarters in Bochum, Germany is home to our Technical, Financial, Sales and Marketing departments. Our team is dedicated and passionate about e-mobility. We are committed to innovation and combine experience in the automotive industry with fresh creative thinking.

Our manufacturing plant in Europe is a state-of-the-art facility which we operate in a partnership with Milara International Ltd., a global leader in robotics manufacturing.

V500e



Contact

Tel.: +49 (0) 2327 327 450
Fax: +49 (0) 2327 327 108

info@sevic.com
www.sevic.com

Address

Sevic Systems SE
Dückerweg 21
44867 Bochum

Germany

**Drive
electric.**

